

4

3

2

1

FIXED-WING

REVISION HISTORY			
REV	DATE	E. C. O. / APPR.	NOTES
A	XX-XX-XX	XXX	NOTES GO HERE

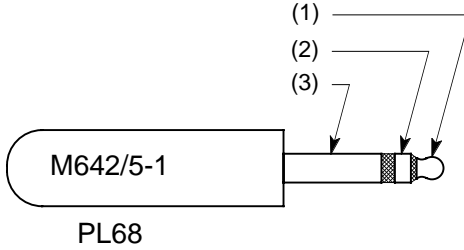
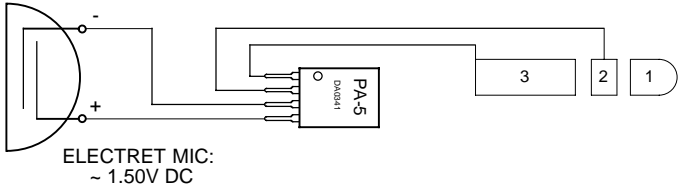
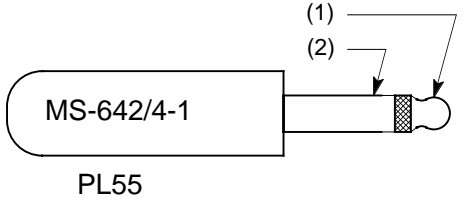
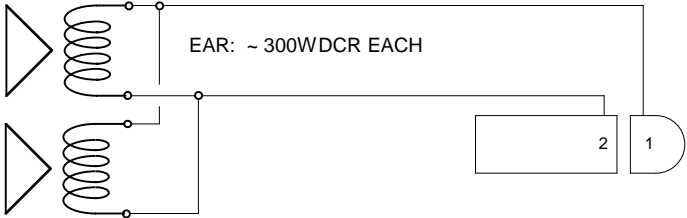
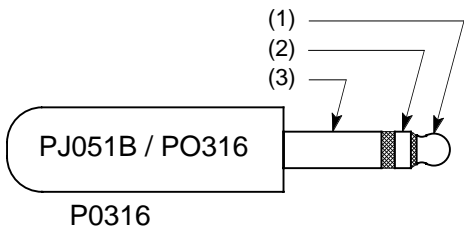
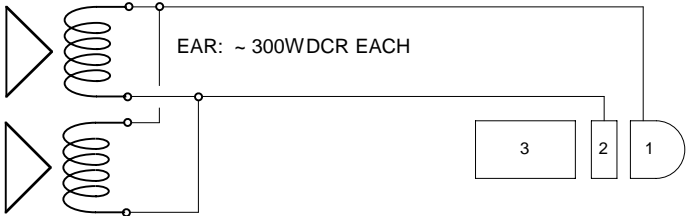

ROTOR-WING

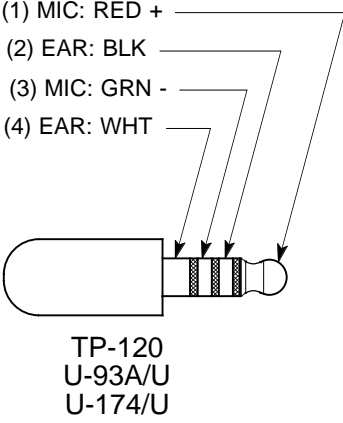
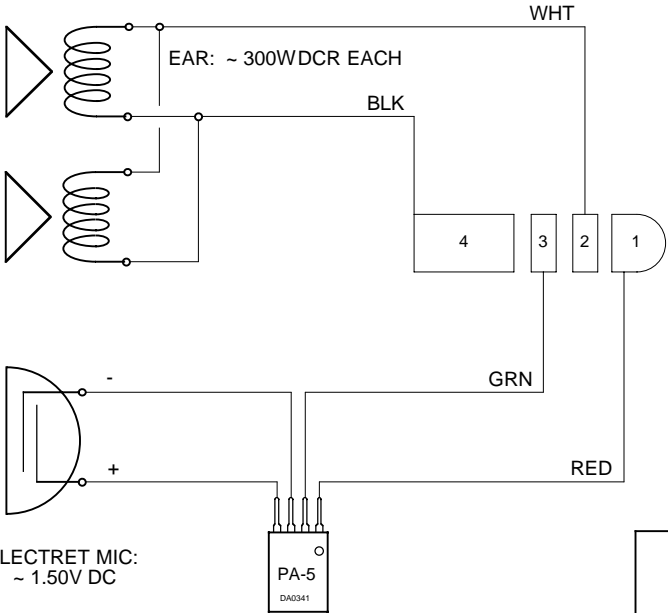

ELECTRET MIC:  
~ 1.50V DC

PA-5  
DA0341

THIRD ANGLE  
PROJECTION.



MOUNTAIN HIGH  
E&S CO.  
REDMOND, OR. USA

ISSUED:	DATE	BASIC HEADSET WIRE CONFIG	
DRAWN: PLM	02-12-99	DWG. #: N Y A	REV -
ENGINEER:	DATE	SIZE A	SHEET 1 OF 1
APPR:	DATE	DO NOT SCALE DRAWING	

4

3

2

1